

FL MC EF WDM-A SC - FO converters



2902658

<https://www.phoenixcontact.com/us/products/2902658>

Please be informed that the data shown in this PDF document is generated from our online catalog. Please find the complete data in the user documentation. Our general terms of use for downloads are valid.



FO converter (replacement device A), for full duplex transmission from 10/100Base-T(X) to individual simplex fiberglass with WDM (wavelength division multiplex) technology, SC simplex fiber optic connection (1310/1550 nm). Device set (type A and type B) required for operation.

Product description

Optical transmission with FO technology provides superior immunity to interference at maximum transmission ranges without restricting the transmission bandwidth.

Your advantages

- Full duplex communication with only one fiber
- Transmission ranges up to 38 km
- Auto negotiation
- Auto MDI/MDI-X switch-over
- Link fault pass through (LFPT) and far end fault (FEF) functions for easy connection monitoring
- 10/100 Mbps
- Shipbuilding approval in accordance with DNV GL

Commercial data

Item number	2902658
Packing unit	1 pc
Minimum order quantity	1 pc
Sales key	DN06
Product key	DNC311
Catalog page	Page 350 (C-6-2019)
GTIN	4046356669689
Weight per piece (including packing)	170.35 g
Weight per piece (excluding packing)	114.52 g
Customs tariff number	85176200
Country of origin	DE

Technical data

Notes

Utilization restriction

EMC note	EMC: class A product, see manufacturer's declaration in the download area
----------	---

Utilization restriction

CCCex note	Use in potentially explosive areas is not permitted in China.
------------	---

Product properties

Product type	Media converter
MTTF	1400 Years (SN 29500 standard, temperature 25°C, operating cycle 21%)
	599 Years (SN 29500 standard, temperature 40°C, operating cycle 34.25%)
	101 Years (SN 29500 standard, temperature 40°C, operating cycle 100%)
MTBF	492 Years (Telcordia standard, 25°C temperature, 21% operating cycle (5 days a week, 8 hours a day))
	133 Years (Telcordia standard, 40°C temperature, 34.25% operating cycle (5 days a week, 12 hours a day))
Signal delay	± 1.3 μs (Store and Forward mode, 10/100 Mbps, depending on the frame size)

System properties

Functionality

Basic functions	Store-and-forward media converter
-----------------	-----------------------------------

Electrical properties

Electrical isolation	according to IEEE 802.3
	VCC // FE // Ethernet
Maximum power dissipation for nominal condition	2.64 W
Test voltage data interface/power supply	0.5 kV _{rms} (50 Hz, 1 min.)

Supply

Supply voltage range	18 V DC ... 30 V DC (Screw connection)
	18 V DC ... 30 V DC (as an alternative or redundant, via backplane bus contact and system current supply)
Typical current consumption	< 110 mA (24 V DC)
Protective circuit	Reverse polarity protection

Connection data

Supply

Connection method	Plug-in screw terminal block (COMBICON), redundancy possible
-------------------	--

FL MC EF WDM-A SC - FO converters



2902658

<https://www.phoenixcontact.com/us/products/2902658>

Single conductor/terminal point, rigid	0.2 mm ² ... 2.5 mm ²
Single-wire/terminal point, flexible	0.2 mm ² ... 2.5 mm ²
Conductor cross section, flexible [AWG]	24 ... 14
Stripping length	7.00 mm
Tightening torque	0.56 Nm ... 0.79 Nm

Interfaces

Signal	Ethernet
Basic functions	Store-and-forward media converter

Data: optical FO

Transmit capacity, minimum	≥ -14 dBm ((9/125 μm) dynamic in link mode (average))
Transmit capacity, maximum	≤ -8 dBm ((9/125 μm) dynamic in link mode (average))
Transmission length incl. 3 dB system reserve	38 km (F-E 9/125 0.36 dB/km)
	34 km (F-E 9/125 0.4 dB/km)
	28 km (F-E 9/125 0.5 dB/km)
	21 km (F-G 62.5/125 0.7 dB/km F 1000)
	5.5 km (F-G 62.5/125 2.6 dB/km F 600)
	21 km (F-G 50/125 0.7 dB/km F 1200)
	9 km (F-G 50/125 1.6 dB/km F 800)
Connection method	SC simplex
Wavelength	1310 nm (Send)
	1550 nm (Receiving)
Minimum receiver sensitivity	-31 dBm (dynamic in link mode (average))
Maximum receiver sensitivity	-3 dBm (dynamic in link mode (average))
Transmission medium	Multi-mode fiberglass
	Single-mode fiberglass

Data: Ethernet interface, 10/100Base-T(X) in accordance with IEEE 802.3

Transmission speed	10/100 Mbps
Connection method	RJ45 jack, shielded
No. of channels	1
Transmission length	100 m (shielded twisted pair)
Transmission medium	Copper
Signal LEDs	Activity, link status, 10/100 Mbps
Auto-negotiation modes	Auto
Link through	Link fault pass through
MDI-/MDI-X switchover	Auto-MDI(X)

Dimensions

FL MC EF WDM-A SC - FO converters



2902658

<https://www.phoenixcontact.com/us/products/2902658>

Dimensional drawing	
Width	22.5 mm
Height	99 mm
Depth	114.5 mm

Material specifications

Color (Housing)	green (RAL 6021)
Material (Housing)	PA 6.6-FR

Cable/line

FO cable

Fiber types	50/125 µm
	62.5/125 µm
	Fiberglass

Environmental and real-life conditions

Ambient conditions

Degree of protection	IP20
Ambient temperature (operation)	-40 °C ... 65 °C
Ambient temperature (storage/transport)	-40 °C ... 85 °C
Altitude	≤ 5000 m (For restrictions, see the manufacturer's declaration for altitude operation)
	≤ 2000 m (in acc. with UL)
Permissible humidity (operation)	5 % ... 95 % (non-condensing)
Permissible humidity (storage/transport)	5 % ... 95 % (non-condensing)

Approvals

CE

Certificate	CE-compliant
-------------	--------------

ATEX

Identification	⊕ II 3 G Ex nA IIC T4 Gc X
Note	Please follow the special installation instructions in the documentation!

UL, USA/Canada

Identification	508 Listed
	Class I, Zone 2, AEx nA IIC T4
	Class I, Zone 2, Ex nA IIC T4 Gc X

FL MC EF WDM-A SC - FO converters



2902658

<https://www.phoenixcontact.com/us/products/2902658>

	Class I, Div. 2, Groups A, B, C, D
--	------------------------------------

Corrosive gas test

Identification	ISA-S71.04-1985 G3 Harsh Group A
----------------	----------------------------------

Shipbuilding

Identification	DNV GL
----------------	--------

DNV GL data

Temperature	B
Humidity	A
Vibration	A
EMC	B
Enclosure	Required protection according to the Rules shall be provided upon installation on board

EMC data

Electromagnetic compatibility	Conformance with EMC Directive 2014/30/EU
-------------------------------	---

Electrostatic discharge

Standards/regulations	EN 61000-4-2
-----------------------	--------------

Electrostatic discharge

Contact discharge	± 6 kV (Test Level 3)
Discharge in air	± 8 kV (Test Level 3)
Indirect discharge	± 6 kV
Comments	Criterion B

Electromagnetic HF field

Standards/regulations	EN 61000-4-3
-----------------------	--------------

Electromagnetic HF field

Frequency range	80 MHz ... 3 GHz (Test Level 3)
Field intensity	10 V/m
Comments	Criterion A

Fast transients (burst)

Standards/regulations	EN 61000-4-4
-----------------------	--------------

Fast transients (burst)

Input	± 2 kV (Test Level 3)
Signal	± 2 kV (Test Level 3)
Comments	Criterion B

Surge current load (surge)

Standards/regulations	EN 61000-4-5
-----------------------	--------------

Surge current load (surge)

Input	± 0.5 kV (DC supply)
-------	----------------------

FL MC EF WDM-A SC - FO converters



2902658

<https://www.phoenixcontact.com/us/products/2902658>

Signal	± 1 kV (Data line, asymmetrical)
Comments	Criterion B

Conducted interference

Standards/regulations	EN 61000-4-6
-----------------------	--------------

Conducted interference

Frequency range	0.15 MHz ... 80 MHz
Comments	Criterion A
Voltage	10 V

Emitted interference

Standards/regulations	EN 55032
Comments	Class A, industrial applications

Criteria

Criterion A	Normal operating behavior within the specified limits.
Criterion B	Temporary impairment to operational behavior that is corrected by the device itself.

Standards and regulations

Free from substances that could impair the application of coating	in accordance with VW-AUDI-Seat central standard P-VW 3.10.7 57 65 0
Electrical isolation	according to IEEE 802.3

Mounting

Mounting type	DIN rail mounting
---------------	-------------------

FL MC EF WDM-A SC - FO converters



2902658

<https://www.phoenixcontact.com/us/products/2902658>

Drawings

Dimensional drawing

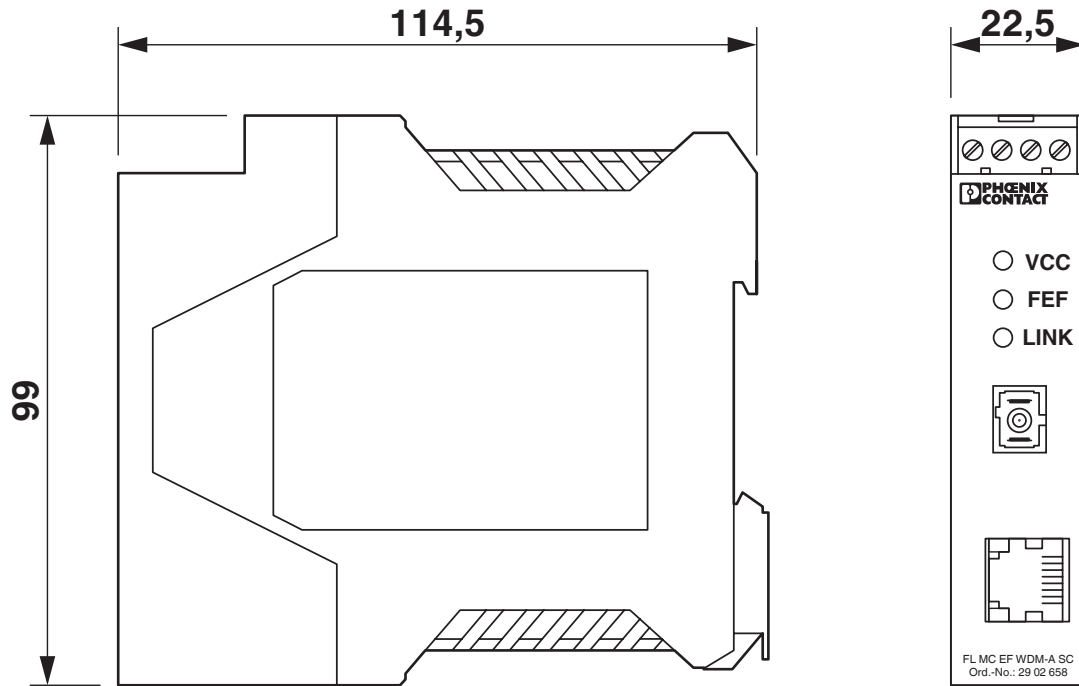

Slim design

Application drawing

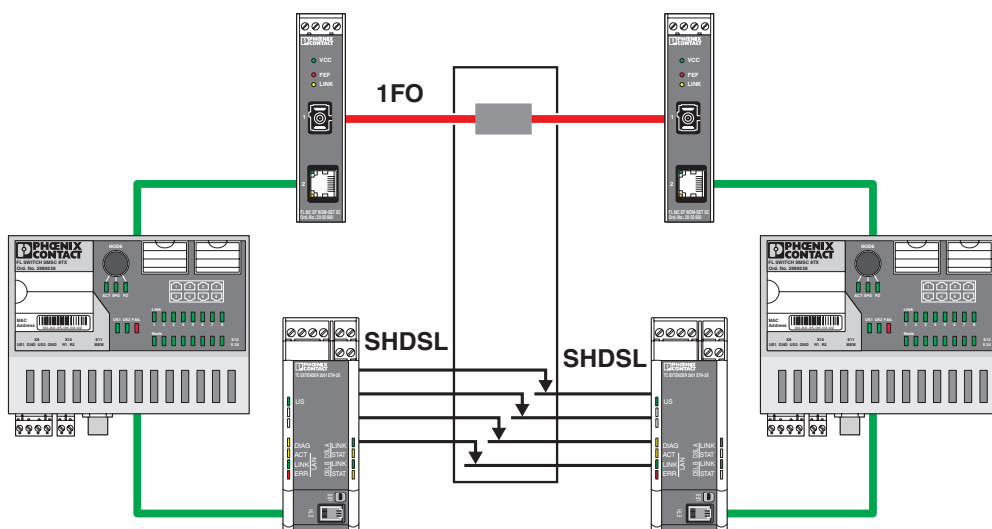

Redundant slip ring communication

FL MC EF WDM-A SC - FO converters

2902658

<https://www.phoenixcontact.com/us/products/2902658>



Schematic diagram

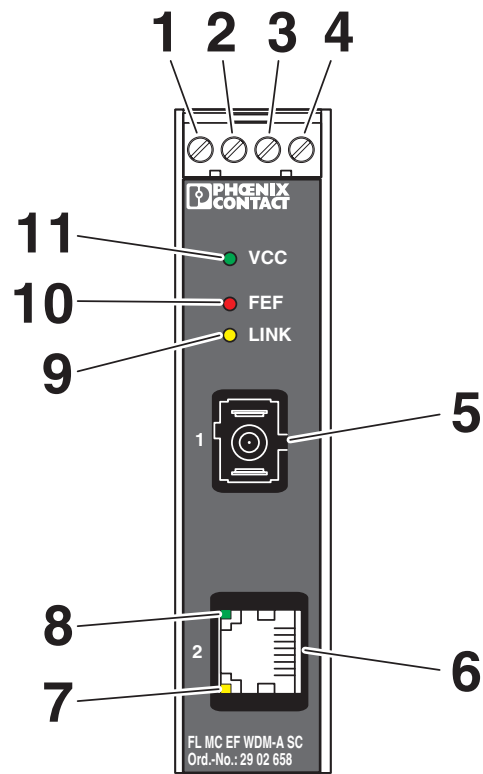

Front view

FL MC EF WDM-A SC - FO converters

2902658

<https://www.phoenixcontact.com/us/products/2902658>

Schematic diagram

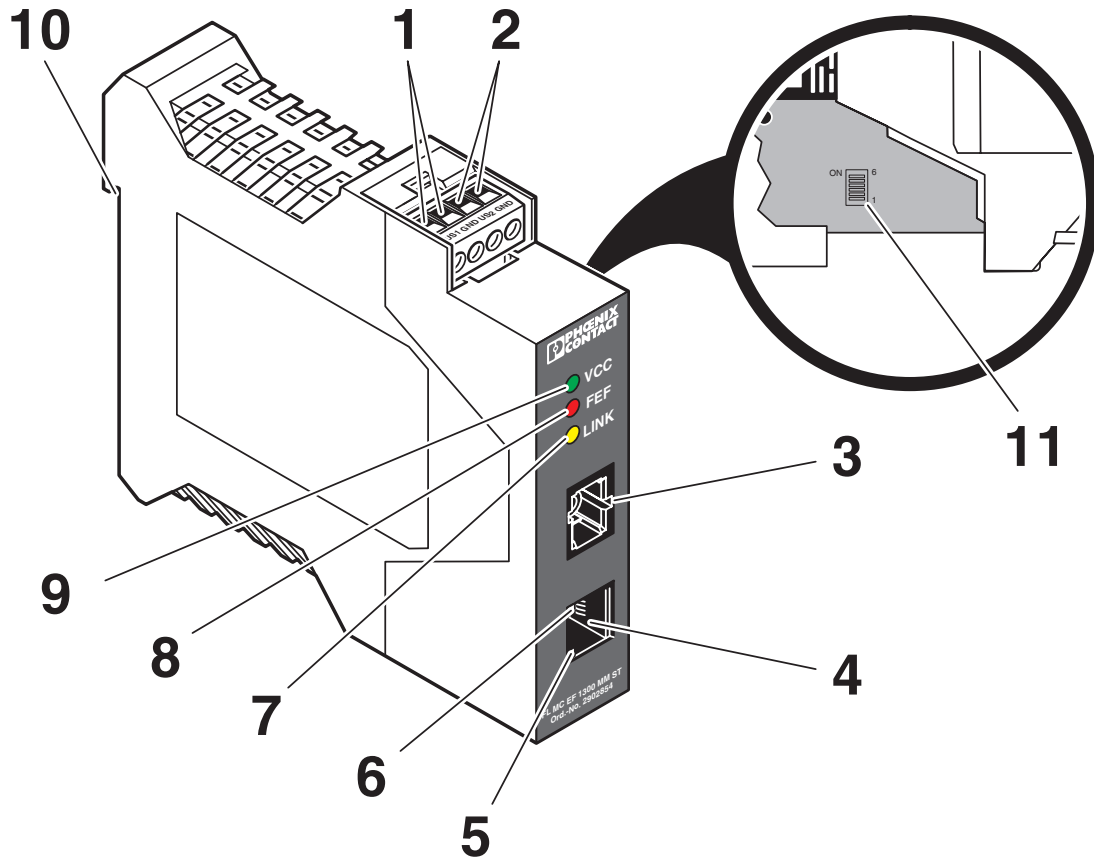

Function elements

FL MC EF WDM-A SC - FO converters



2902658

<https://www.phoenixcontact.com/us/products/2902658>

Schematic diagram

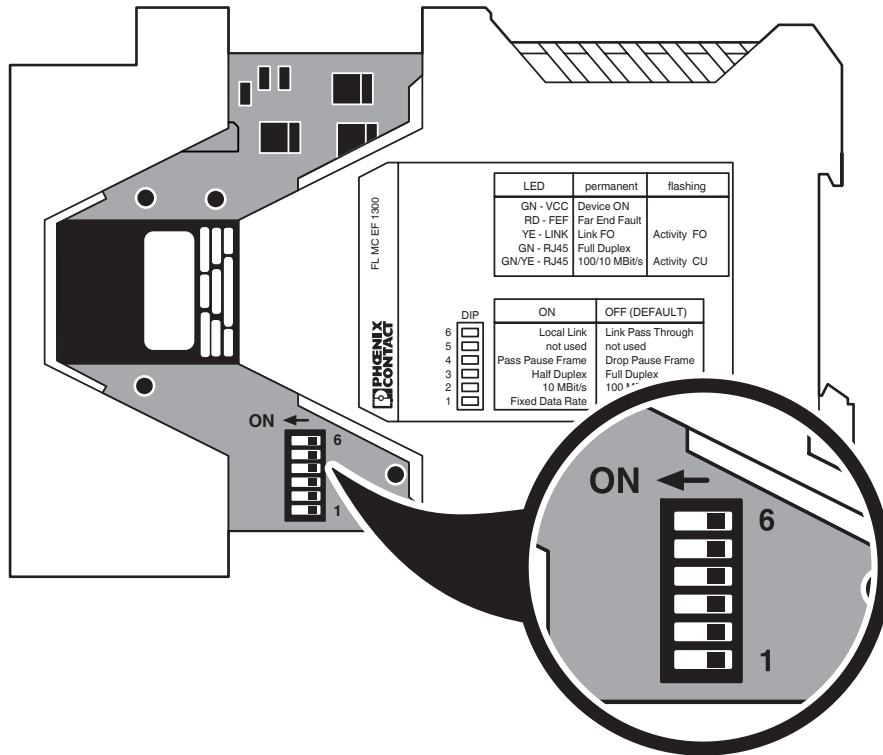

DIP switches

Schematic diagram

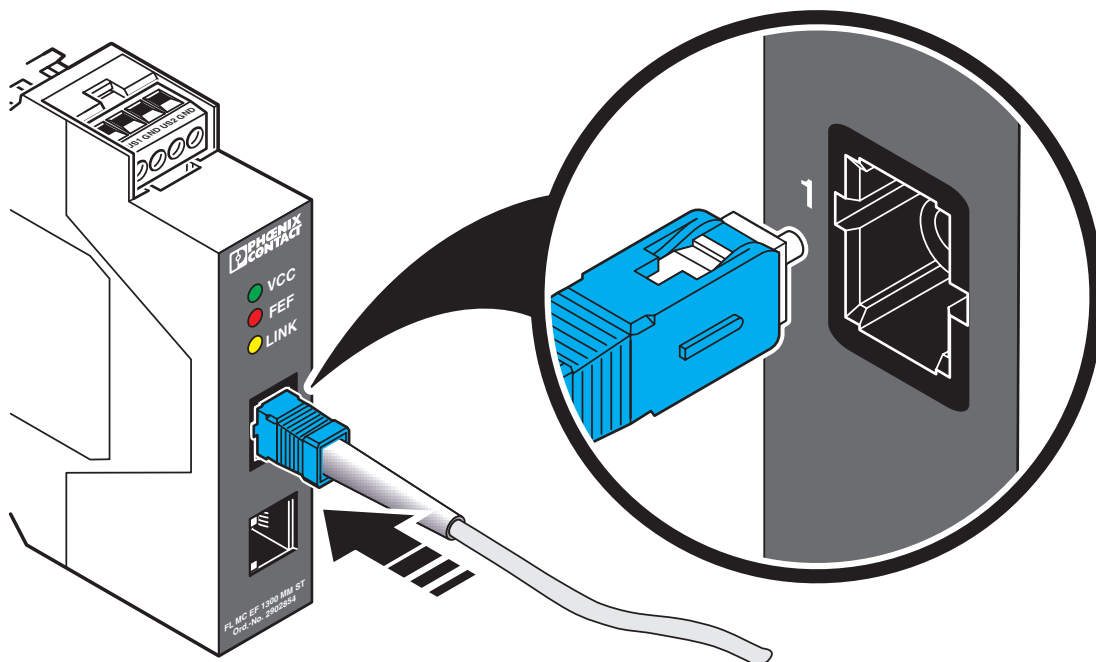

Connect SC simplex plug

FL MC EF WDM-A SC - FO converters



2902658

<https://www.phoenixcontact.com/us/products/2902658>

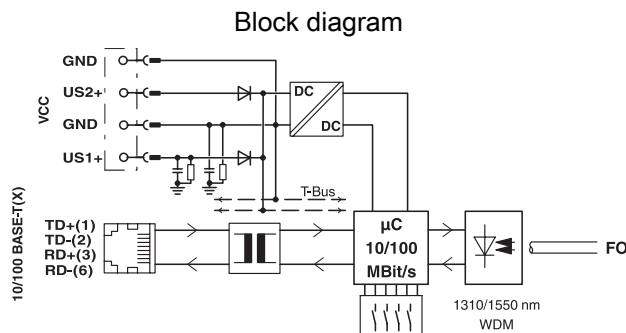

Basic circuit diagram

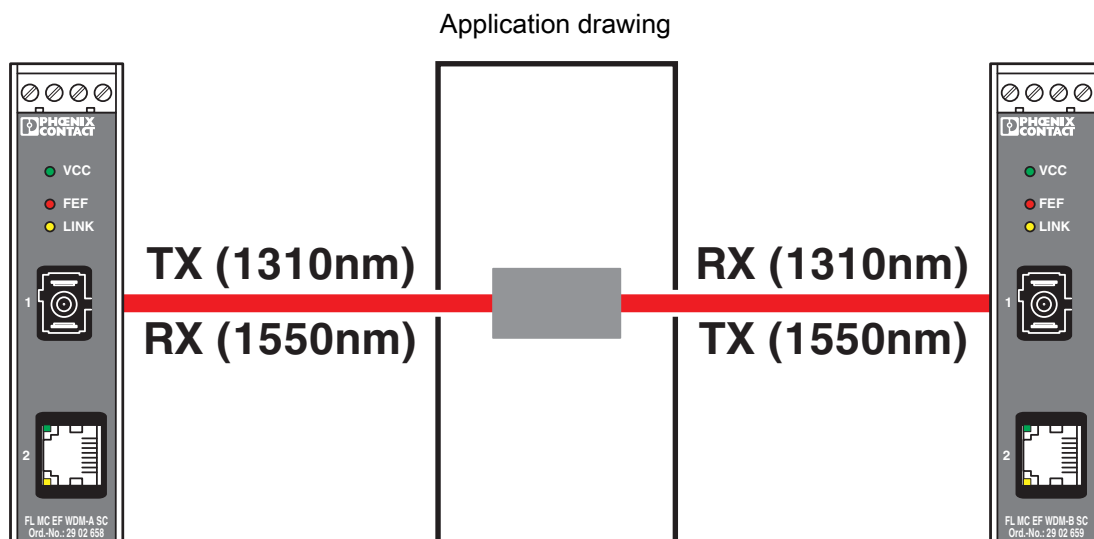

Slip ring communication

2902658

<https://www.phoenixcontact.com/us/products/2902658>

Approvals

To download certificates, visit the product detail page: <https://www.phoenixcontact.com/us/products/2902658>



DNV GL

Approval ID: TAA00001KR



UL Listed

Approval ID: FILE E 238705



cUL Listed

Approval ID: FILE E 238705



DNV GL

Approval ID: TAA00001KR



cUL Listed

Approval ID: FILE E 199827



UL Listed

Approval ID: FILE E 199827



UL Listed

Approval ID: FILE E 199827



cUL Listed

Approval ID: FILE E 199827

cULus Listed

FL MC EF WDM-A SC - FO converters



2902658

<https://www.phoenixcontact.com/us/products/2902658>

Classifications

ECLASS

ECLASS-11.0	19170411
ECLASS-12.0	19170411
ECLASS-13.0	19170411

ETIM

ETIM 9.0	EC001467
----------	----------

UNSPSC

UNSPSC 21.0	43201500
-------------	----------

2902658

<https://www.phoenixcontact.com/us/products/2902658>

Environmental product compliance

EU RoHS

Fulfills EU RoHS substance requirements	Yes
Exemption	7(a), 7(c)-I

China RoHS

Environment friendly use period (EFUP)	EFUP-50
	An article-related China RoHS declaration table can be found in the download area for the respective article under "Manufacturer declaration". For all articles with EFUP-E, no China RoHS declaration table issued and required.

EU REACH SVHC

REACH candidate substance (CAS No.)	Lead(CAS: 7439-92-1)
SCIP	862777cc-fcec-4b65-9f9a-bd97a220b912

FL MC EF WDM-A SC - FO converters

2902658

<https://www.phoenixcontact.com/us/products/2902658>



Accessories

FL MC EF WDM-SET SC - FO converters

2902660

<https://www.phoenixcontact.com/us/products/2902660>



FO converter set, consisting of type A devices and type B devices, for full duplex transmission from 10/100Base-T(X) to individual simplex fiberglass with WDM (wavelength division multiplex) technology. SC simplex fiber optic connection (1550/1310 nm).

FL CAT5 HEAVY - Data cable

2744814

<https://www.phoenixcontact.com/us/products/2744814>



CAT5-SF/UTP cable (J-02YS(ST)C HP 2 x 2 x 24 AWG), heavy-duty installation cable, 2 x 2 x 0.22 mm², solid conductor, shielded, outer sheath: 7.8 mm diameter, inner sheath: 5.75 mm ± 0.15 mm diameter

FL MC EF WDM-A SC - FO converters

2902658

<https://www.phoenixcontact.com/us/products/2902658>



FL CAT5 FLEX - Installation cable

2744830

<https://www.phoenixcontact.com/us/products/2744830>



By the meter, Installation cable, Ethernet CAT5 (100 Mbps), shielded, PUR halogen-free, water blue RAL 5021, 4-wire (2x2xAWG26/7, SF/UTP), color single wire: white/orange-orange, white/green-green, cable length: Free entry (1.0 ... 1000.0 m)

FL CRIMPTOOL - Assembly tool

2744869

<https://www.phoenixcontact.com/us/products/2744869>



Crimping pliers, for assembling the RJ45 plugs FL PLUG RJ45..., for assembly on site

FL MC EF WDM-A SC - FO converters

2902658

<https://www.phoenixcontact.com/us/products/2902658>



ME 22,5 TBUS 1,5/ 5-ST-3,81 GN - DIN rail bus connectors

2707437

<https://www.phoenixcontact.com/us/products/2707437>

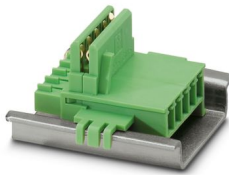

DIN rail connector, color: green, nominal current: 8 A (parallel contacts), rated voltage (III/2): 125 V, number of positions: 5, product range: TBUS5-22,5..., pitch: 3.81 mm, mounting: DIN rail mounting, locking: without, mounting: without, type of packaging: packed in cardboard, Item with gold-plated contacts, bus connectors for connecting with electronics housings, 5 parallel contacts

QUINT4-SYS-PS/1AC/24DC/2.5/SC - Power supply unit

2904614

<https://www.phoenixcontact.com/us/products/2904614>



Primary-switched power supply, QUINT POWER, screw connection, DIN rail mounting, supply of devices possible via the TBUS DIN rail connector, protective coating, input: single-phase, output: 24 V DC/2.5 A

FL MC EF WDM-A SC - FO converters

2902658

<https://www.phoenixcontact.com/us/products/2902658>



ME 17,5 TBUS 1,5/ 5-ST-3,81 GN - DIN rail bus connectors

2709561

<https://www.phoenixcontact.com/us/products/2709561>

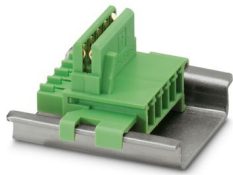

DIN rail connector for DIN rail mounting. Universal for TBUS housing. Gold-plated contacts, 5-pos.

ME 17,5 TBUS 1,5/ 5-ST-3,81 KMGY - DIN rail bus connectors

2713645

<https://www.phoenixcontact.com/us/products/2713645>

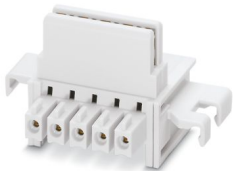

DIN rail connector, color: light grey, nominal current: 8 A (parallel contacts), rated voltage (III/2): 125 V, number of positions: 5, product range: TBUS5-17,5..., pitch: 3.81 mm, mounting: DIN rail mounting, locking: without, mounting: without, type of packaging: packed in cardboard, Item with gold-plated contacts, bus connectors for connecting with electronics housings, 5 parallel contacts

FL MC EF WDM-A SC - FO converters



2902658

<https://www.phoenixcontact.com/us/products/2902658>

FOC-LC:PA-SC:PA-OM2:D01/1 - FO patch cable

1115607

<https://www.phoenixcontact.com/us/products/1115607>

Multi-mode OM2 duplex jumper, LC-SC, UPC polishing, length 1 m

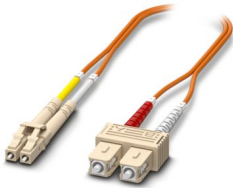

FOC-LC:PA-SC:PA-OM2:D01/2 - FO patch cable

1115605

<https://www.phoenixcontact.com/us/products/1115605>

Multi-mode OM2 duplex jumper, LC-SC, UPC polishing, length 2 m

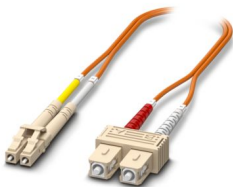

FL MC EF WDM-A SC - FO converters

2902658

<https://www.phoenixcontact.com/us/products/2902658>

FOC-SC:PA-SC:PA-OM2:D01/1 - FO patch cable

1115536

<https://www.phoenixcontact.com/us/products/1115536>

Multi-mode OM2 duplex jumper, SC-SC, UPC polishing, length 1 m

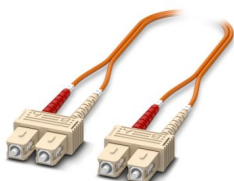

FOC-SC:PA-SC:PA-OM2:D01/2 - FO patch cable

1115535

<https://www.phoenixcontact.com/us/products/1115535>

Multi-mode OM2 duplex jumper, SC-SC, UPC polishing, length 2 m

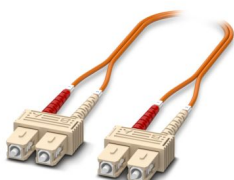

FL MC EF WDM-A SC - FO converters

2902658

<https://www.phoenixcontact.com/us/products/2902658>

FOC-ST:PA-SC:PA-OM2:D01/1 - FO patch cable

1115574

<https://www.phoenixcontact.com/us/products/1115574>

Multi-mode OM2 duplex jumper, ST-SC, UPC polishing, length 1 m

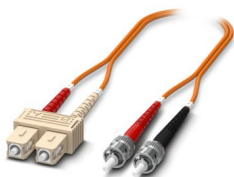

FOC-ST:PA-SC:PA-OM2:D01/2 - FO patch cable

1115573

<https://www.phoenixcontact.com/us/products/1115573>

Multi-mode OM2 duplex jumper, ST-SC, UPC polishing, length 2 m

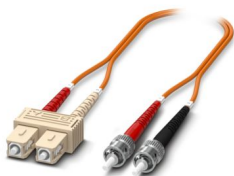

FL MC EF WDM-A SC - FO converters

2902658

<https://www.phoenixcontact.com/us/products/2902658>

FOC-LC:PA-SC:PA-OM4:D01/1 - FO patch cable

1115601

<https://www.phoenixcontact.com/us/products/1115601>

Multi-mode OM4 duplex jumper, LC-SC, UPC polishing, length 1 m

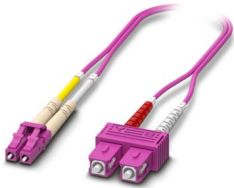

FOC-LC:PA-SC:PA-OM4:D01/2 - FO patch cable

1115600

<https://www.phoenixcontact.com/us/products/1115600>

Multi-mode OM4 duplex jumper, LC-SC, UPC polishing, length 2 m

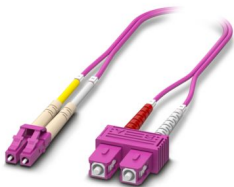

FL MC EF WDM-A SC - FO converters

2902658

<https://www.phoenixcontact.com/us/products/2902658>

FOC-SC:PA-SC:PA-OM4:D01/1 - FO patch cable

1115424

<https://www.phoenixcontact.com/us/products/1115424>

Multi-mode OM4 duplex jumper, SC-SC, UPC polishing, length 1 m

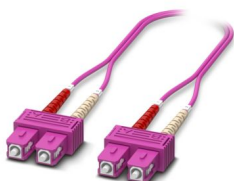

FOC-SC:PA-SC:PA-OM4:D01/2 - FO patch cable

1115423

<https://www.phoenixcontact.com/us/products/1115423>

Multi-mode OM4 duplex jumper, SC-SC, UPC polishing, length 2 m

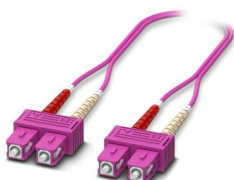

FL MC EF WDM-A SC - FO converters

2902658

<https://www.phoenixcontact.com/us/products/2902658>

VS-08-RJ45-5-Q/IP20 - RJ45 connector

1656725

<https://www.phoenixcontact.com/us/products/1656725>



RJ45 connector, design: RJ45, degree of protection: IP20, number of positions: 8, 1 Gbps, CAT5, material: Plastic, connection method: Insulation displacement connection, connection cross section: AWG 26- 23, cable outlet: straight, color: traffic grey A RAL 7042, Ethernet

VS-08-RJ45-5-Q/IP20 BK - RJ45 connector

1658008

<https://www.phoenixcontact.com/us/products/1658008>



RJ45 connector, design: RJ45, degree of protection: IP20, number of positions: 8, 1 Gbps, CAT5, material: Plastic, connection method: Insulation displacement connection, connection cross section: AWG 26- 23, cable outlet: straight, color: black, Ethernet

FL MC EF WDM-A SC - FO converters

2902658

<https://www.phoenixcontact.com/us/products/2902658>

FOC-GDM-RUGGED-1016/IP20/... - FO patch cable

2901558

<https://www.phoenixcontact.com/us/products/2901558>

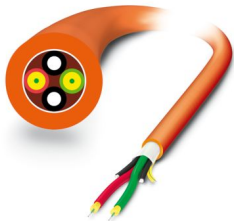

Robust GOF installation cable for assembly (IP20 heads only) for installation in stationary systems and machines, aramid strain-relief elements, with individual elements made from FRNC material, halogen-free, ozone and UV resistant, with a polyurethane (PUR) outer sheath

FOC-GDO-1017/IP20/... - FO patch cable

2901559

<https://www.phoenixcontact.com/us/products/2901559>



Highly rugged GOF round cable (IP20 heads only) for assembly and for outdoor installation with integrated moisture barrier as well as rodent-proof scrim. Individual elements made from highly flexible FRNC material. The wire is ozone and UV resistant with a very rugged polyethylene outer sheath.

FL MC EF WDM-A SC - FO converters

2902658

<https://www.phoenixcontact.com/us/products/2902658>

PSM-LWL-GDO- 50/125 - FO cable

2799432

<https://www.phoenixcontact.com/us/products/2799432>



Fiberglass cable, duplex 50/125 μm , by the meter, without connector, for outdoor installation

PSM-LWL-GDM-RUGGED- 50/125 - FO cable

2799322

<https://www.phoenixcontact.com/us/products/2799322>



Fiber glass cable, duplex 50 μm /125 μm , by the meter, without male connector, for installation in stationary systems and machines

FL MC EF WDM-A SC - FO converters

2902658

<https://www.phoenixcontact.com/us/products/2902658>

FOC-SC:PA-SC:PA-OS2:D01/1 - FO patch cable

1115550

<https://www.phoenixcontact.com/us/products/1115550>

Single-mode OS2 duplex jumper, SC-SC, UPC polishing, length 1 m

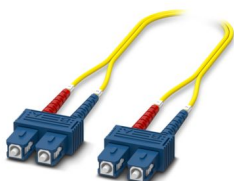

FOC-SC:PA-SC:PA-OS2:D01/2 - FO patch cable

1115548

<https://www.phoenixcontact.com/us/products/1115548>

Single-mode OS2 duplex jumper, SC-SC, UPC polishing, length 2 m

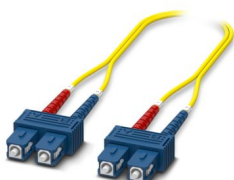

FL MC EF WDM-A SC - FO converters



2902658

<https://www.phoenixcontact.com/us/products/2902658>

FOC-ST:PA-SC:PA-OS2:D01/1 - FO patch cable

1115582

<https://www.phoenixcontact.com/us/products/1115582>

Single-mode OS2 duplex jumper, ST-SC, UPC polishing, length 1 m

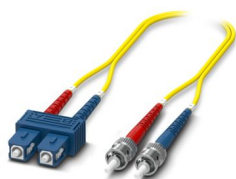

FOC-ST:PA-SC:PA-OS2:D01/2 - FO patch cable

1115581

<https://www.phoenixcontact.com/us/products/1115581>

Single-mode OS2 duplex jumper, ST-SC, UPC polishing, length 2 m

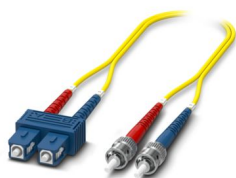

FL MC EF WDM-A SC - FO converters

2902658

<https://www.phoenixcontact.com/us/products/2902658>

FOC-LC:PA-SC:PA-OS2:D01/1 - FO patch cable

1115618

<https://www.phoenixcontact.com/us/products/1115618>

Single-mode OS2 duplex jumper, LC-SC, UPC polishing, length 1 m

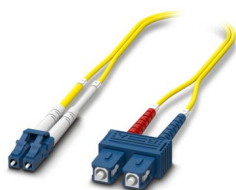

FOC-LC:PA-SC:PA-OS2:D01/2 - FO patch cable

1115617

<https://www.phoenixcontact.com/us/products/1115617>

Single-mode OS2 duplex jumper, LC-SC, UPC polishing, length 2 m

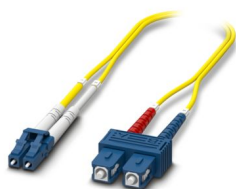

FL MC EF WDM-A SC - FO converters

2902658

<https://www.phoenixcontact.com/us/products/2902658>



FL CAT5 PATCH 0,5 - Patch cable

2832263

<https://www.phoenixcontact.com/us/products/2832263>

Patch cable, CAT5, assembled, 0.5 m



FL CAT5 PATCH 1,0 - Patch cable

2832276

<https://www.phoenixcontact.com/us/products/2832276>

Patch cable, CAT5, assembled, 1 m



FL MC EF WDM-A SC - FO converters

2902658

<https://www.phoenixcontact.com/us/products/2902658>



FL CAT5 PATCH 2,0 - Patch cable

2832289

<https://www.phoenixcontact.com/us/products/2832289>

Patch cable, CAT5, assembled, 2 m



FL CAT5 PATCH 3,0 - Patch cable

2832292

<https://www.phoenixcontact.com/us/products/2832292>

Patch cable, CAT5, assembled, 3 m



FL MC EF WDM-A SC - FO converters

2902658

<https://www.phoenixcontact.com/us/products/2902658>



NBC-R4AC-R4AC-IE8A/.../... - Patch cable

1411854

<https://www.phoenixcontact.com/us/products/1411854>

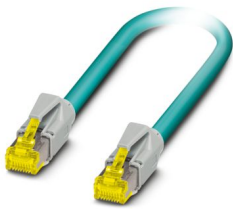

Patch cable, degree of protection: IP20, number of positions: 8, 10 Gbps, CAT6_A, cable outlet: straight, Ethernet

FL MC EF WDM-B SC - FO converters

2902659

<https://www.phoenixcontact.com/us/products/2902659>



FO converter (replacement device B), for full duplex transmission from 10/100Base-T(X) to individual simplex fiberglass with WDM (wavelength division multiplex) technology, SC simplex fiber optic connection (1550/1310 nm). Device set (type A and type B) required for operation.

FL MC EF WDM-A SC - FO converters

2902658

<https://www.phoenixcontact.com/us/products/2902658>



FL MC EF WDM-SET SC - FO converters

2902660

<https://www.phoenixcontact.com/us/products/2902660>



FO converter set, consisting of type A devices and type B devices, for full duplex transmission from 10/100Base-T(X) to individual simplex fiberglass with WDM (wavelength division multiplex) technology. SC simplex fiber optic connection (1550/1310 nm).

Phoenix Contact 2024 © - all rights reserved

<https://www.phoenixcontact.com>

Phoenix Contact USA
586 Fulling Mill Road
Middletown, PA 17057, United States
(+717) 944-1300
info@phoenixcon.com